

Data Sheet



Article number: 0108052

Description: Retaining ring JK 35 DIN 984

Measures

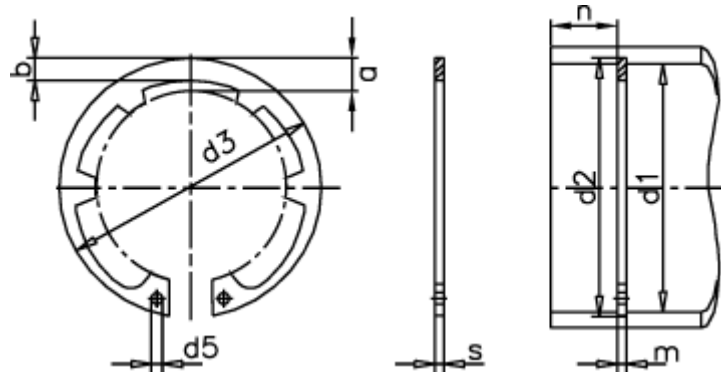

a max	= 5.5	FN kN	= 18.8	s	= 1.50
AN mm ²	= 113.0	FRg kN	= 6.4	t	= 1.00
b	= 3.6	FR kN	= 26.9	tol	= +0,25
d1	= 35	g	= 1.5	tol	= -0.06
d2	= 37.0	K kN-mm	= 50.5	tol	= +0,50-0,25
d3	= 37.8	m min	= 1.60	Tong	= ZGJ-2
d5 min	= 2.5	Nominal drive	= 3.0	Weight kg/1000	= 4.00
Description	= JK 35	Number of serrations	= 6		